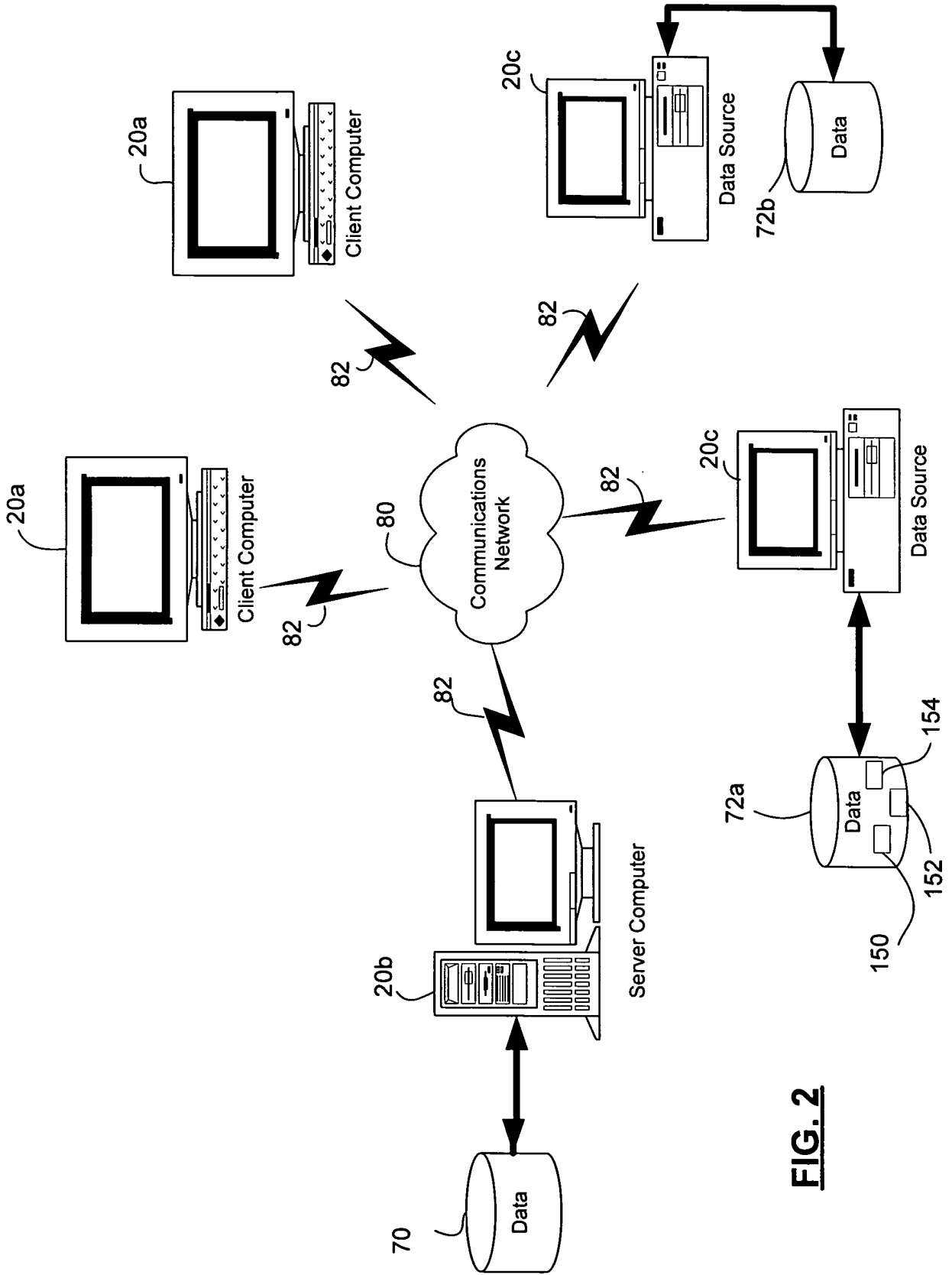
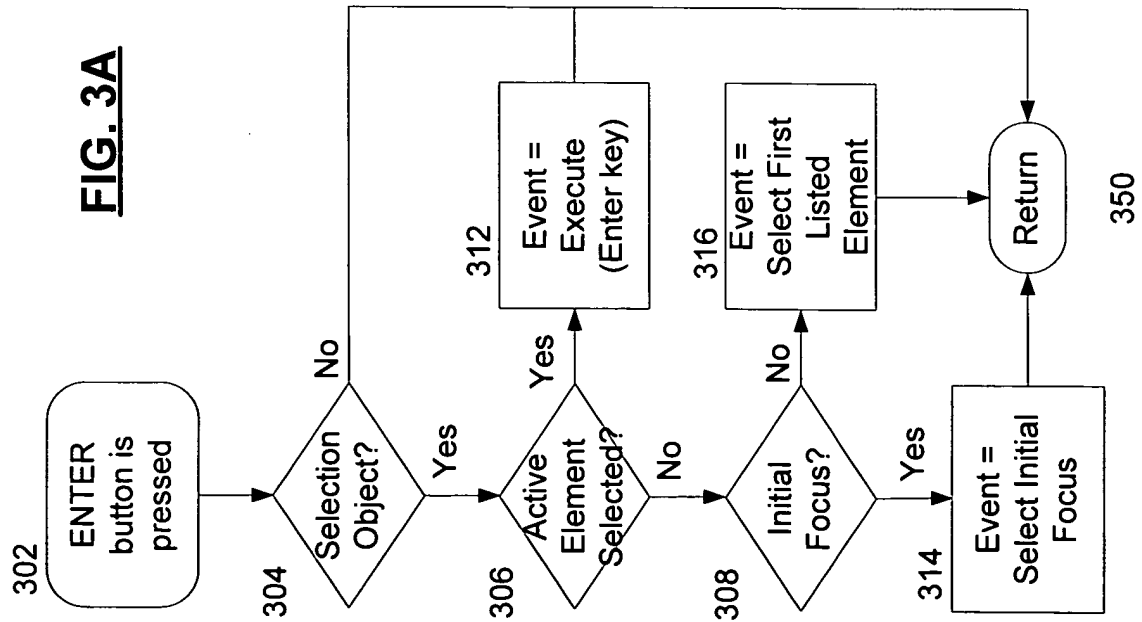
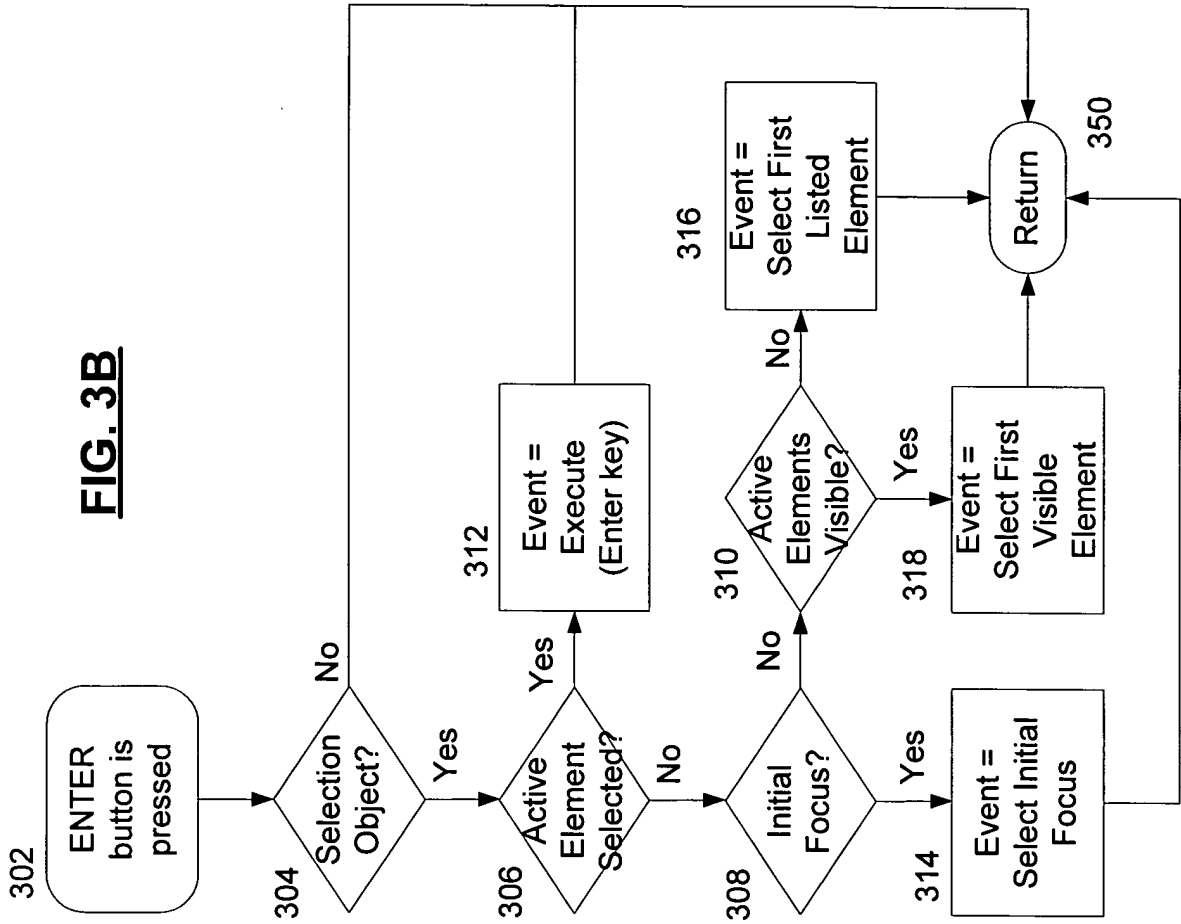


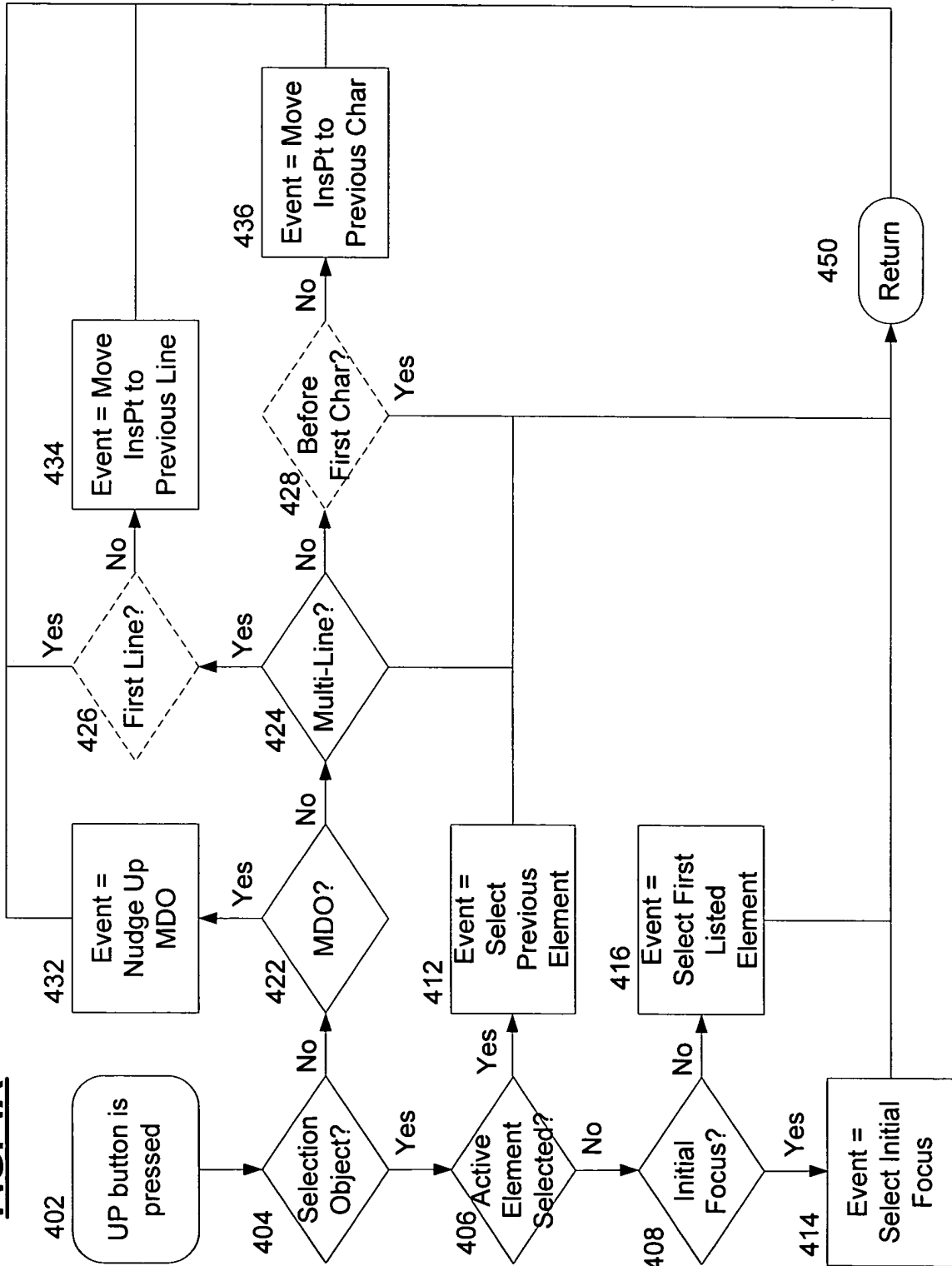
**FIG. 1**



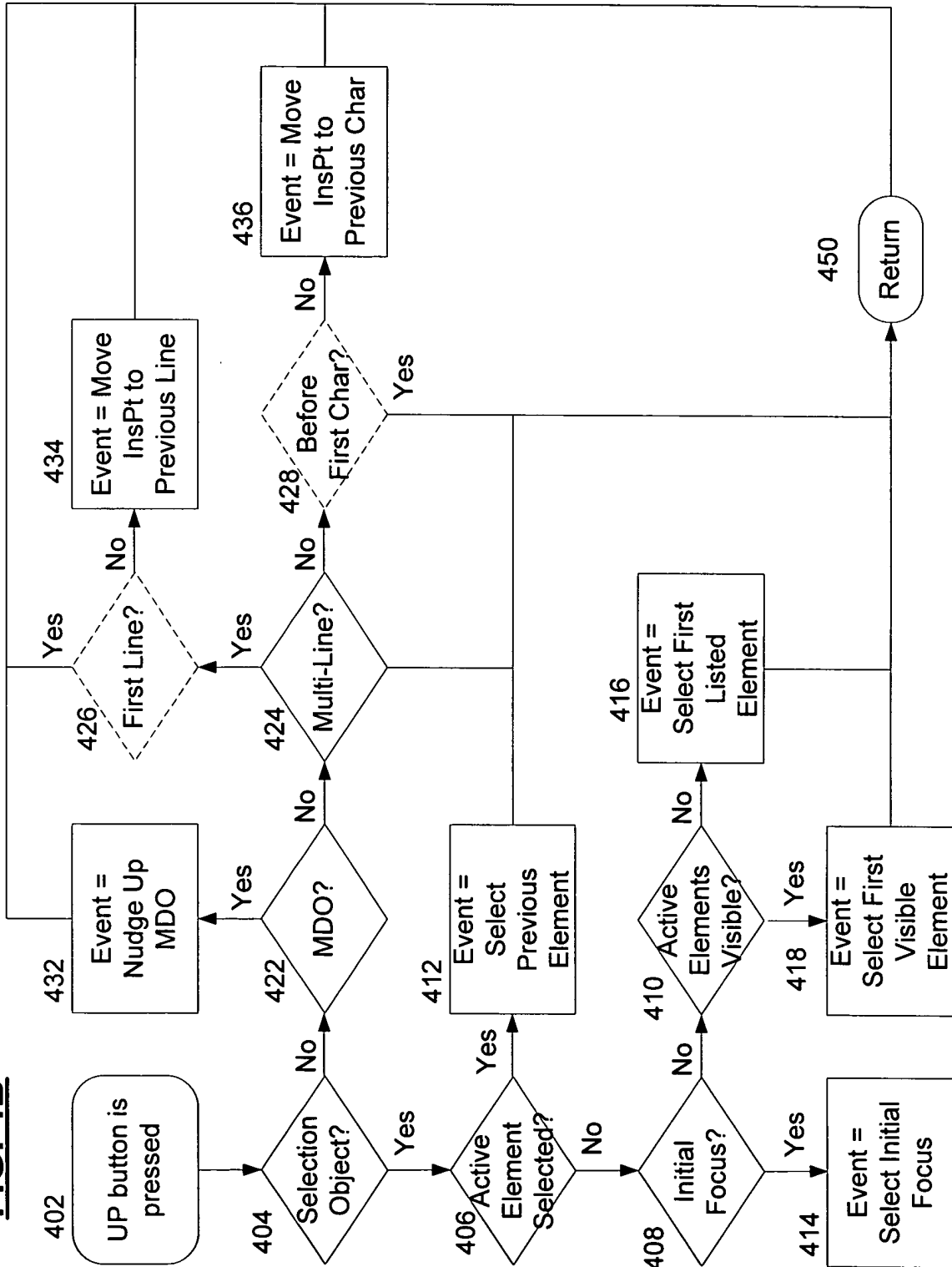
**FIG. 2**



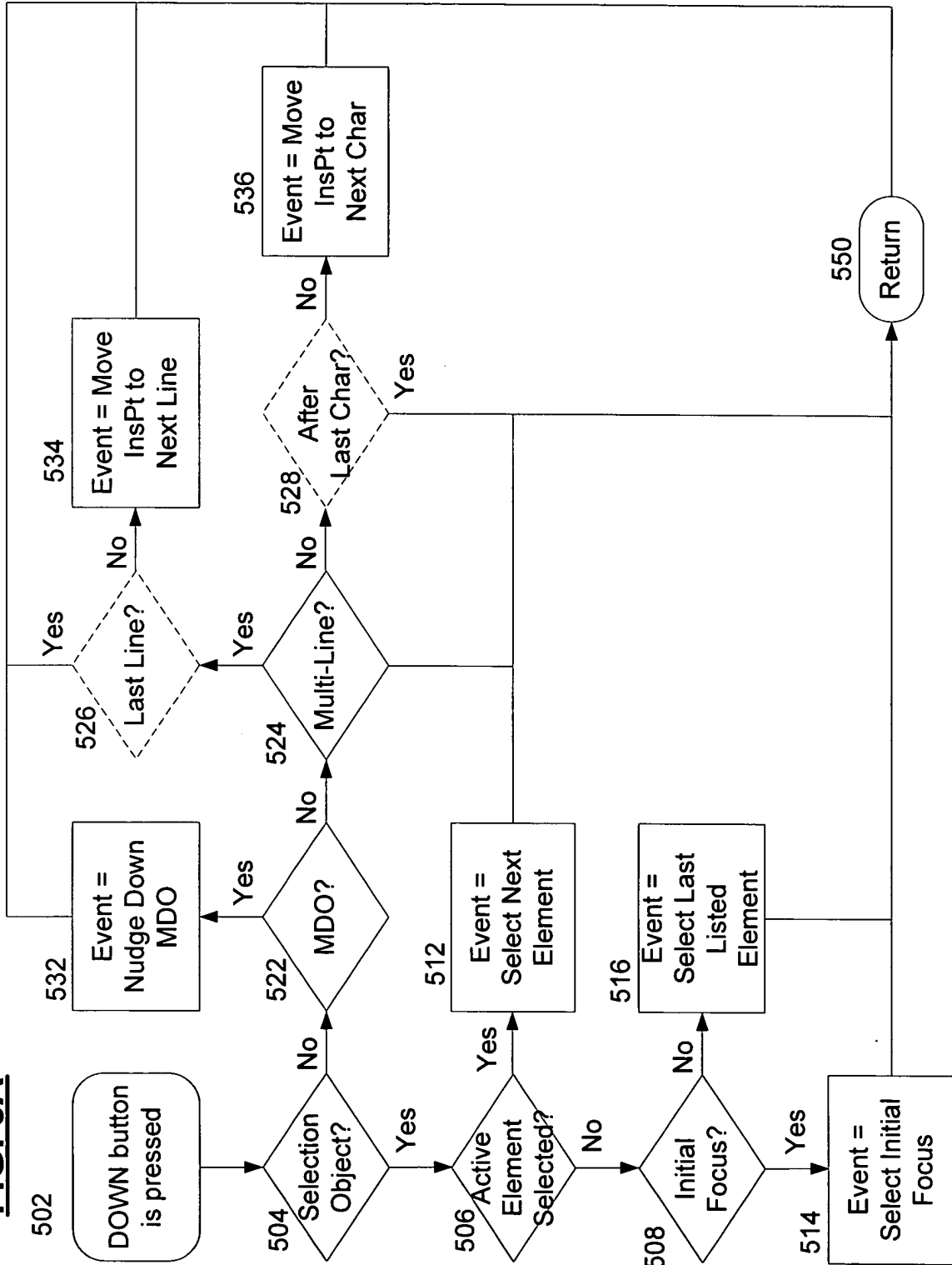
**FIG. 4A**



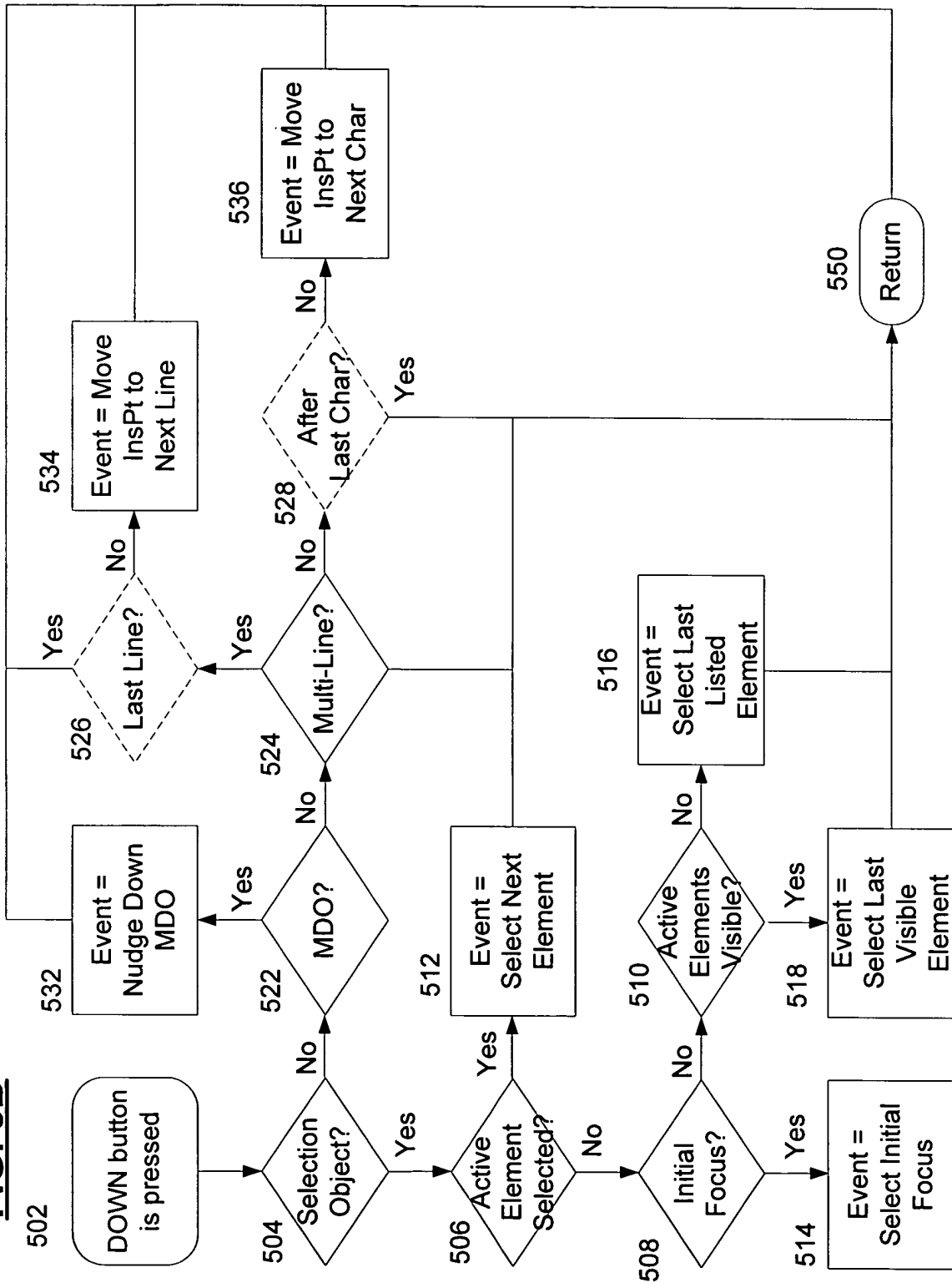
**FIG. 4B**

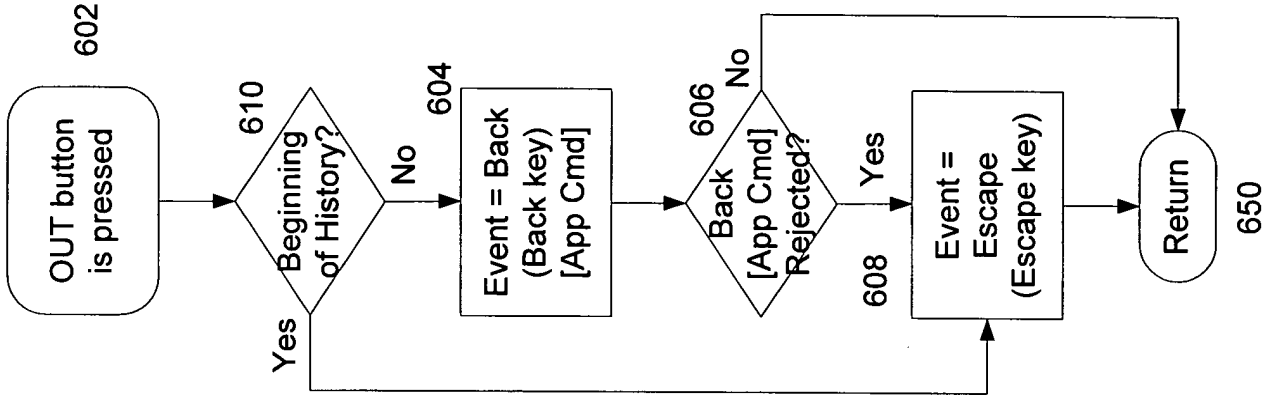


**FIG. 5A**

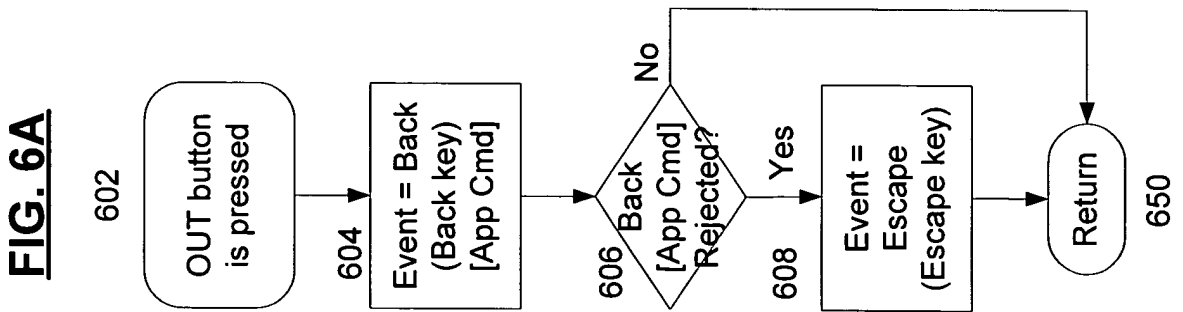


**FIG. 5B**



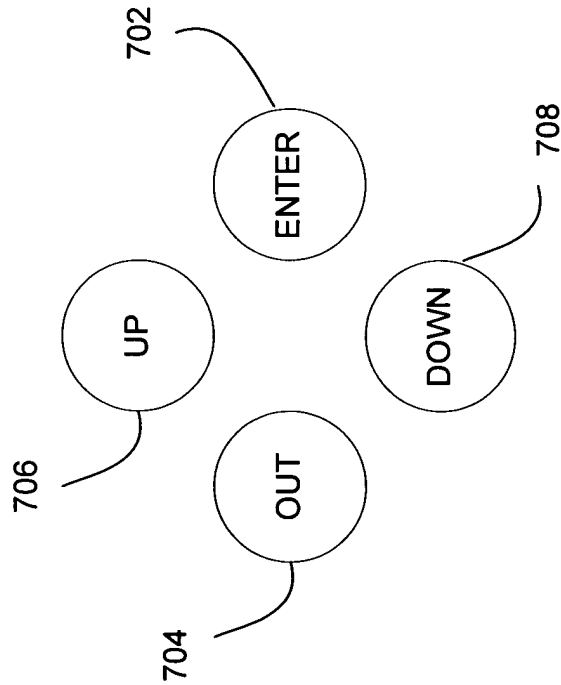


**FIG. 6B**

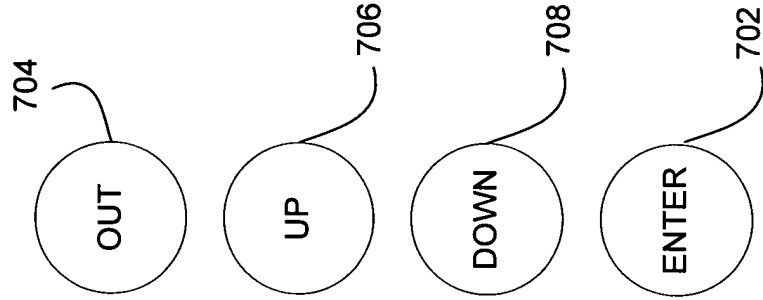


**FIG. 6A**

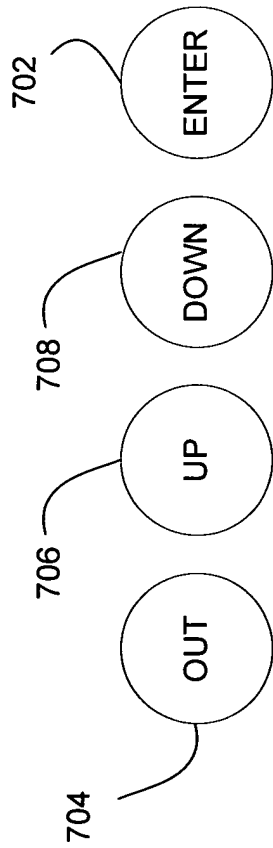




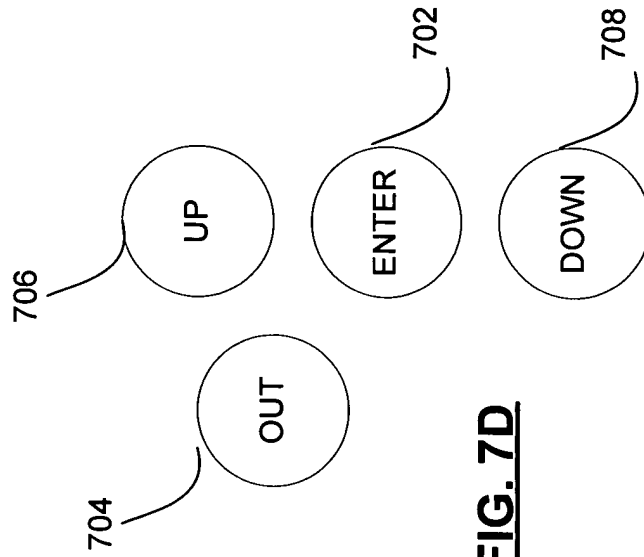
**FIG. 7A**



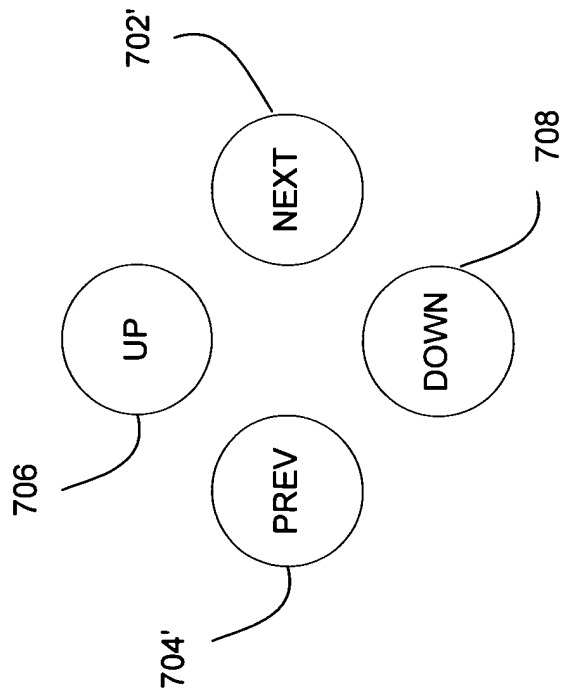
**FIG. 7B**



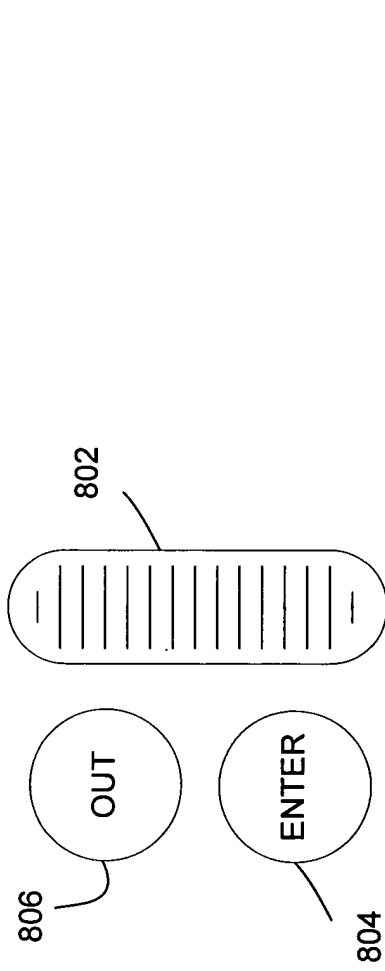
**FIG. 7C**



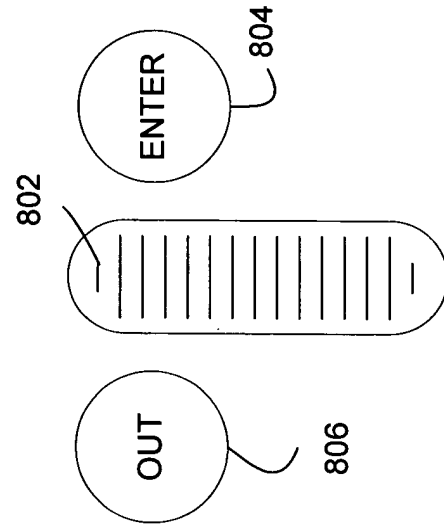
**FIG. 7D**



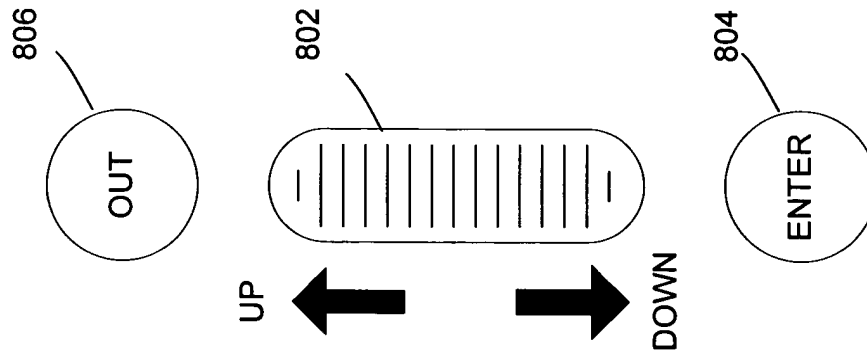
**FIG. 7E**



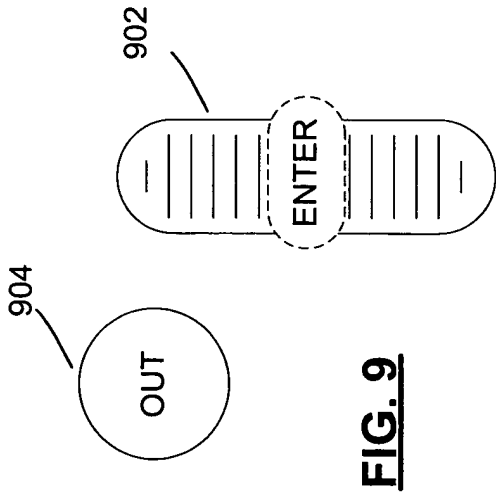
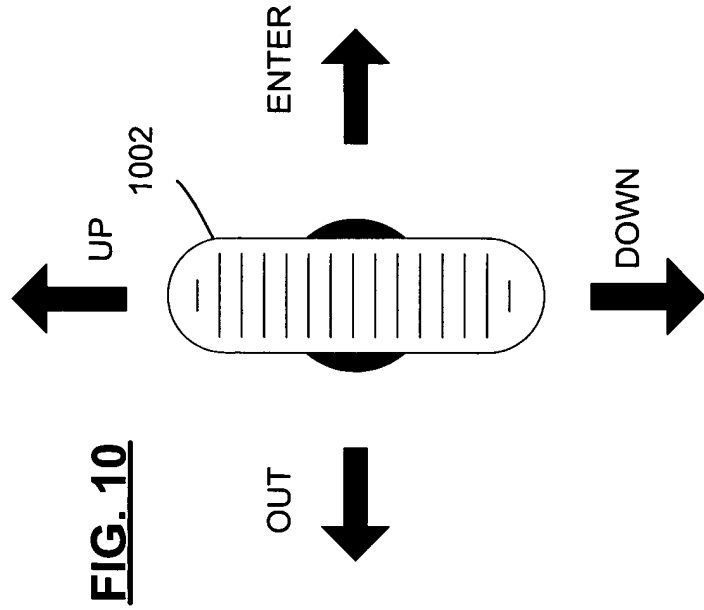
**FIG. 8B**

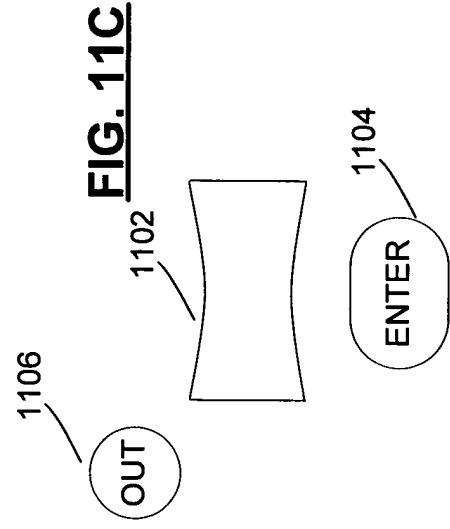
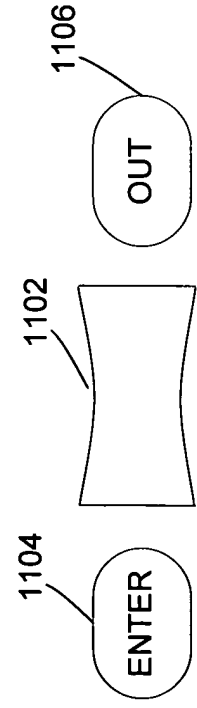
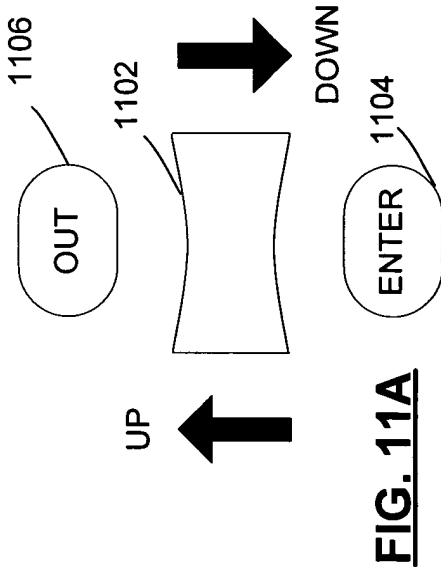


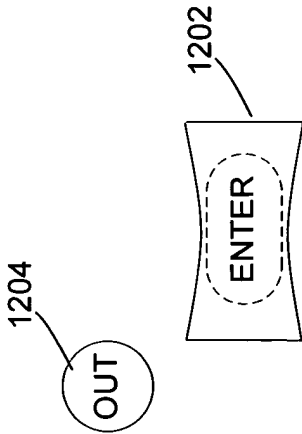
**FIG. 8C**



**FIG. 8A**

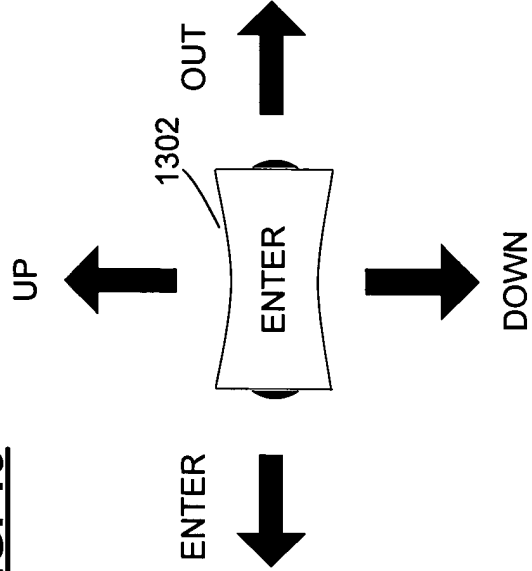




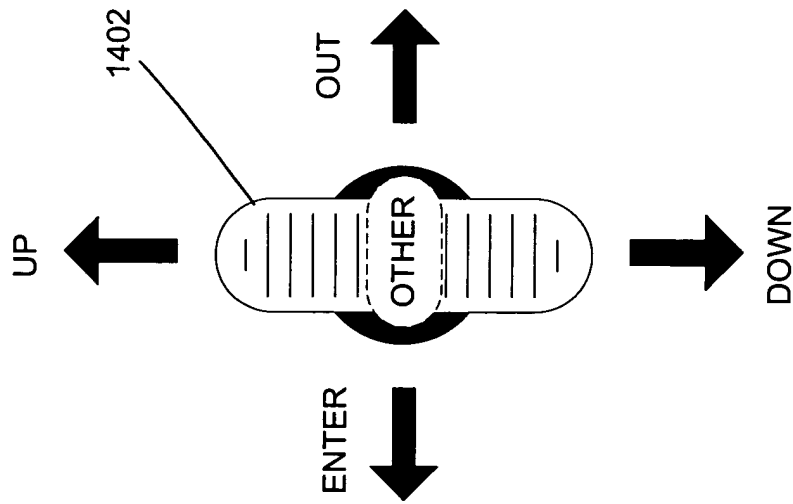


**FIG. 12**

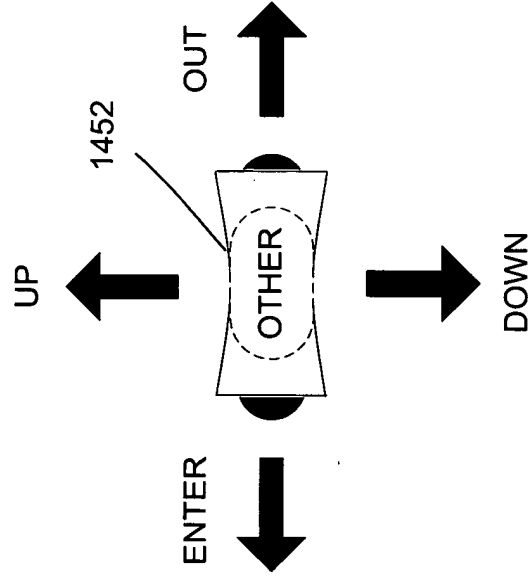
**FIG. 13**



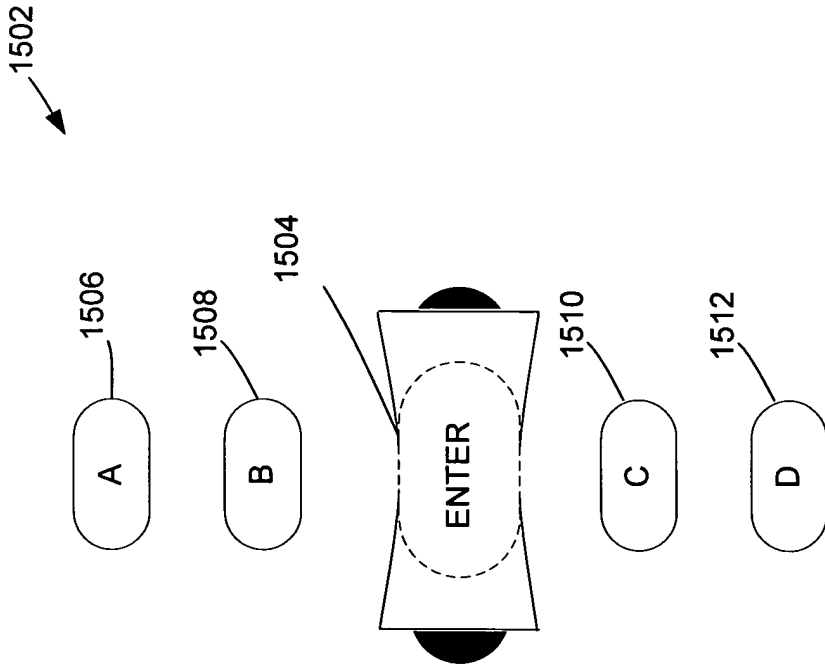
**FIG. 14A**



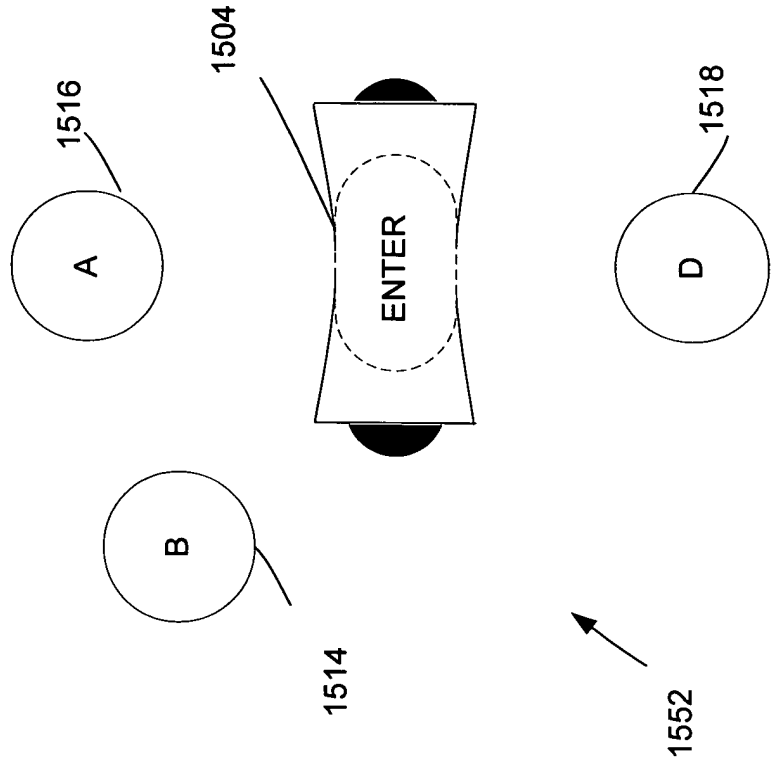
**FIG. 14B**



**FIG. 15A**



**FIG. 15B**



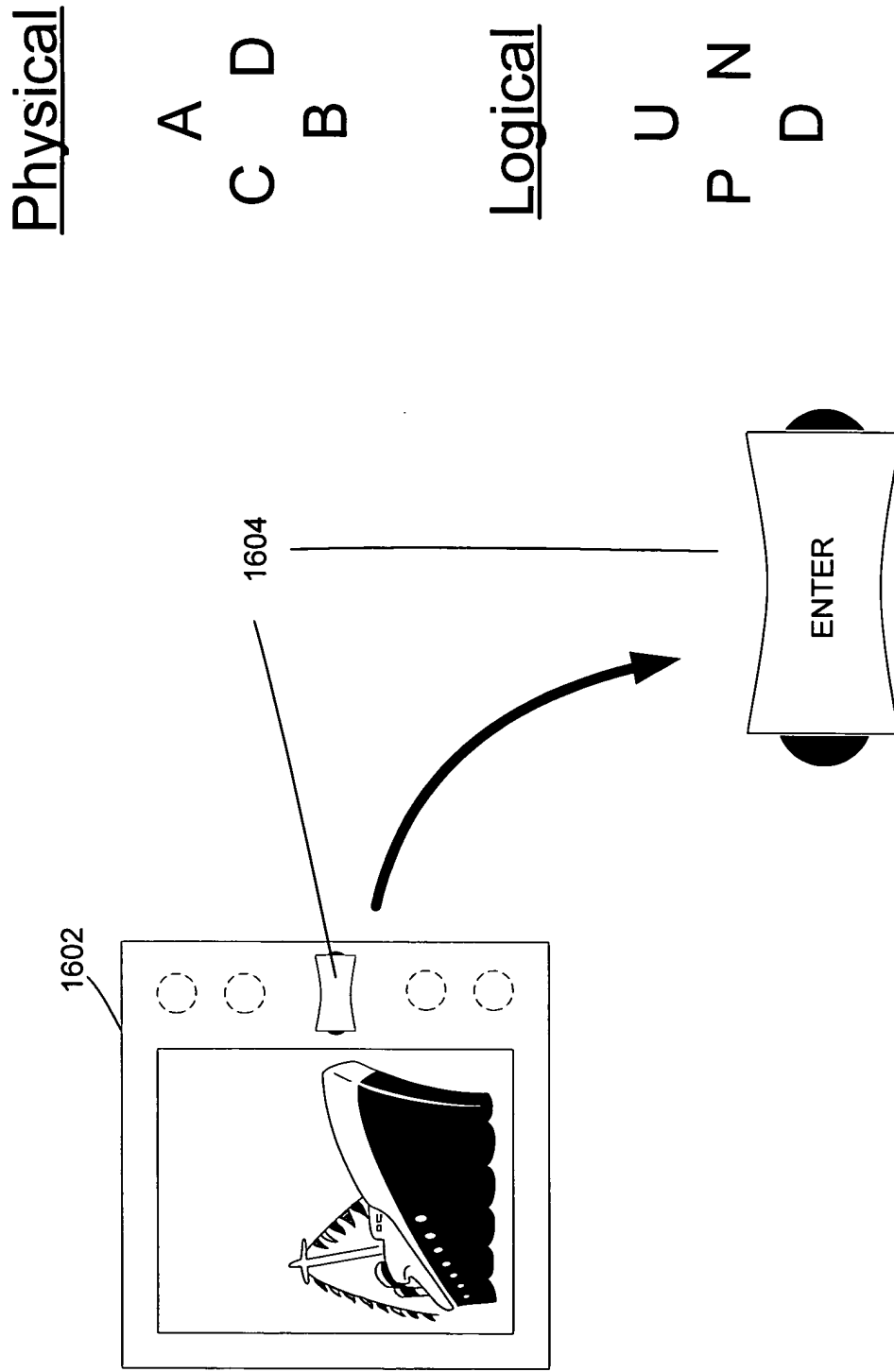


**FIG. 15C**

Logical Button	Activation	Event	Keyboard
SDB	Roll Up	UP	Up (arrow)
SDB	Roll Down	DOWN	Down (arrow)
SDB	Rock Left	PREV	Alt-Tab
SDB	Rock Right	NEXT	Tab
SDB	Press (Click)	ENTER	Enter
Button A	Press	SWTCH	Alt-Esc
Button B	Press	OUT	Back/Esc
Button C	Press	ENTER	Enter
Button D	Press	MORE	Shift-F10

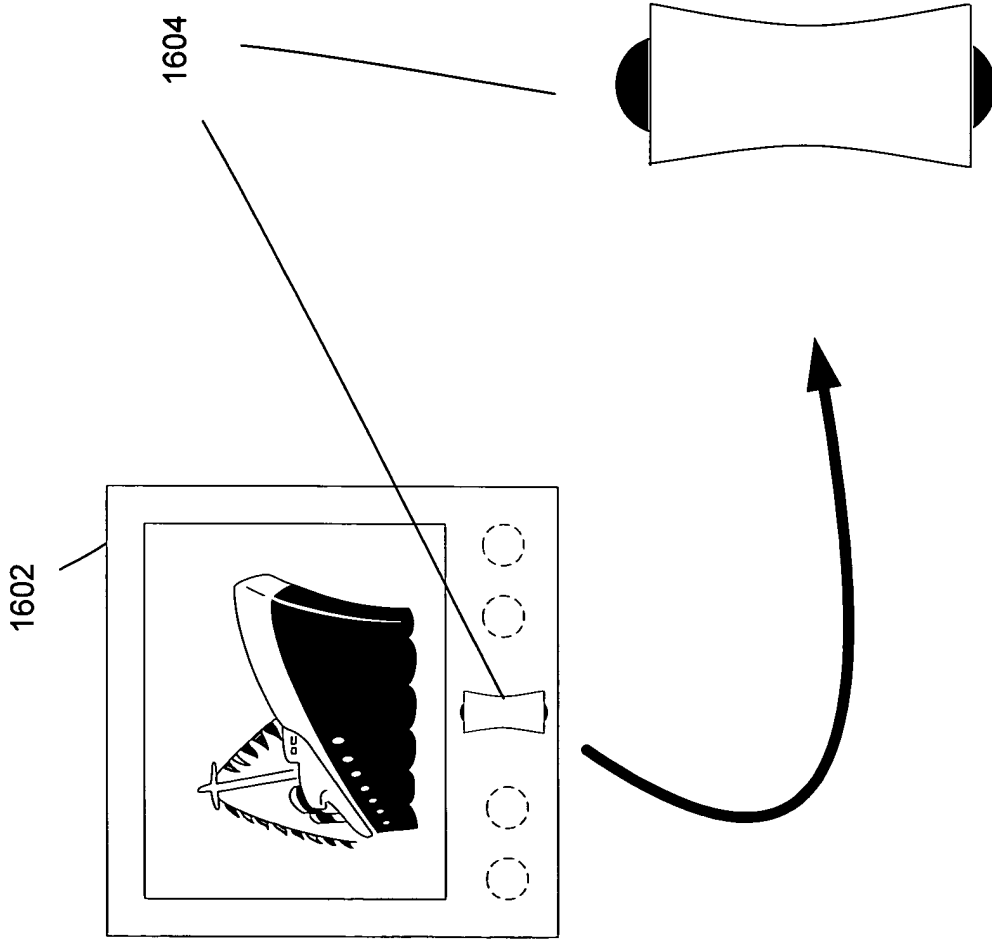
**FIG. 16A**

Original  
Orientation



Rotated One  
 Quarter (90  
 Degrees) to  
 the Right

**FIG. 16B**



Physical

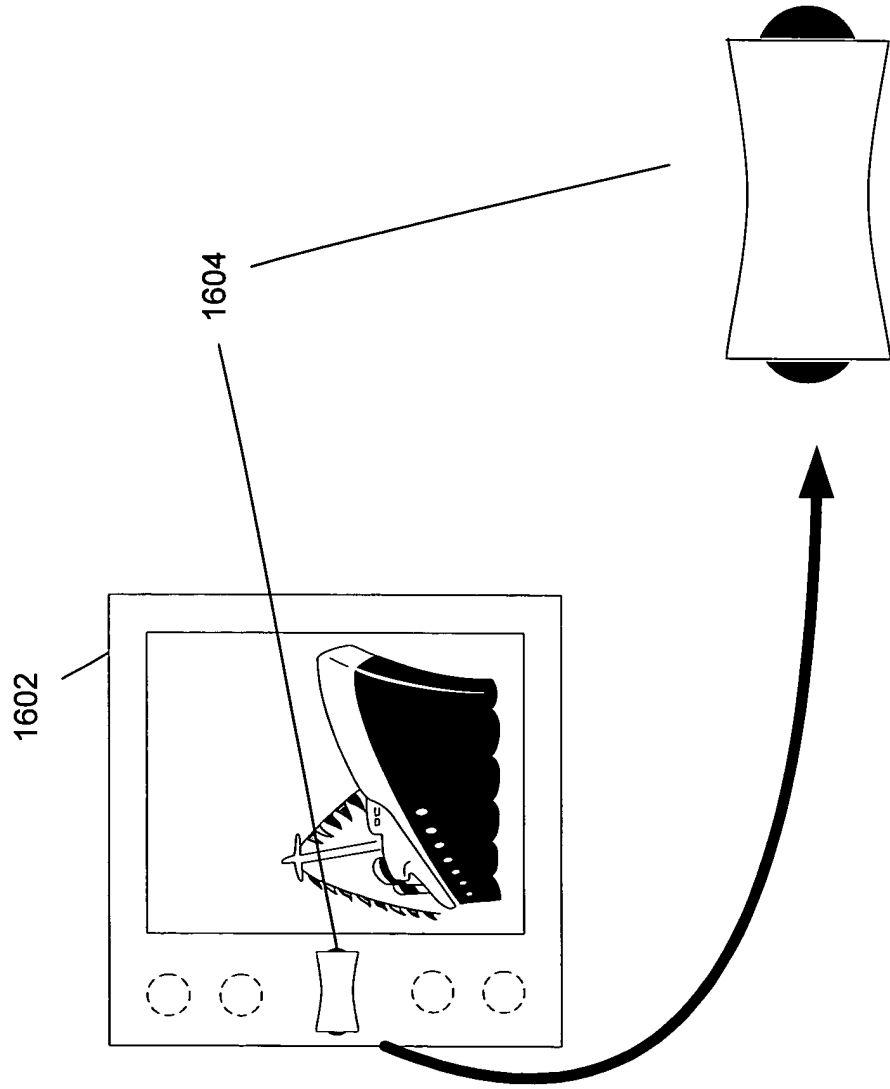
A  
 C B D

Logical

D  
 P U N

Rotated One  
 Half (180  
 Degrees) to  
 the Right

**FIG. 16C**



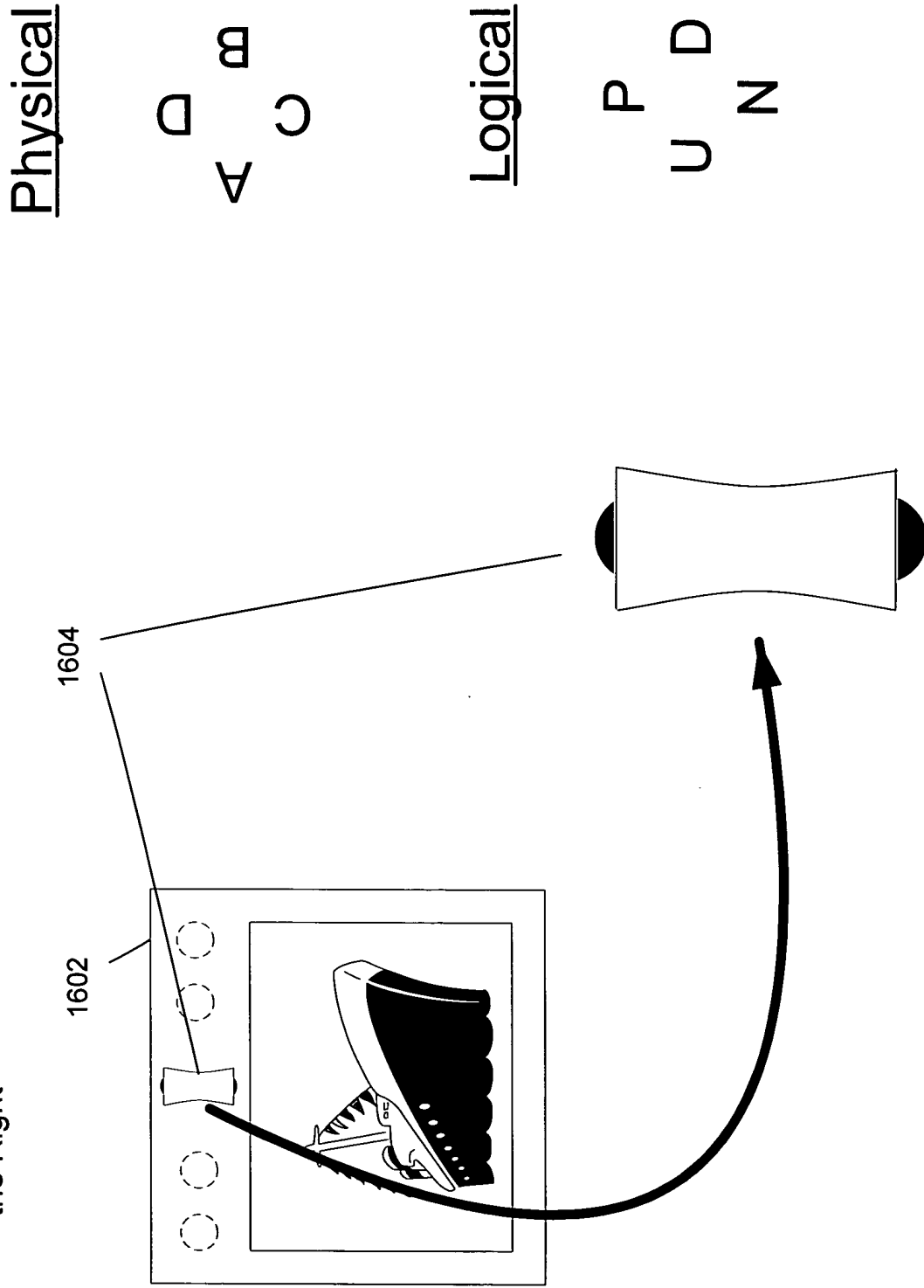
Physical

B C  
 D A

Logical

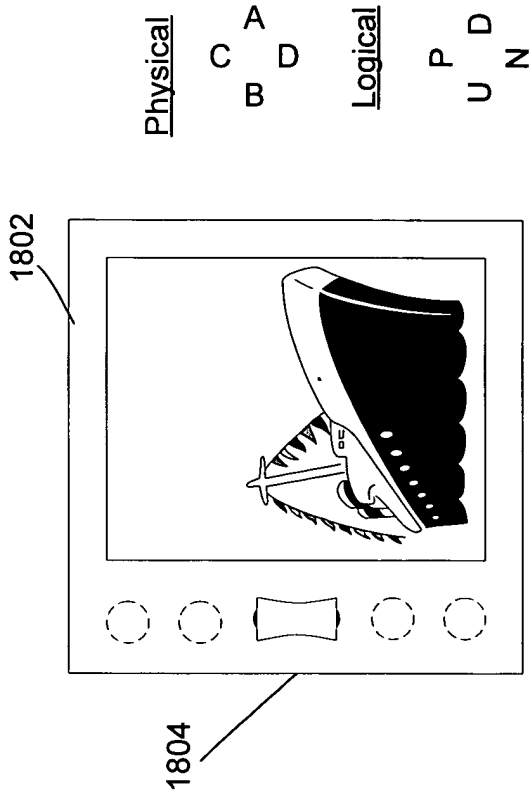
U N  
 P D

**FIG. 16D**  
Rotated Three  
Quarters (270  
Degrees) to  
the Right

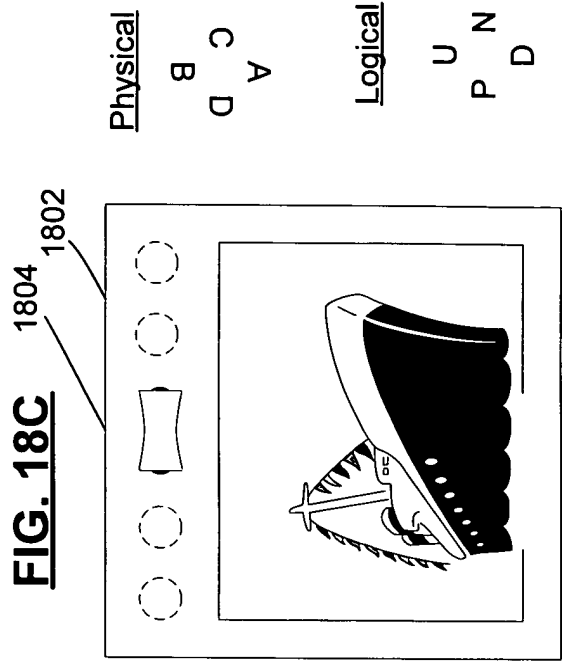


**FIG. 17**

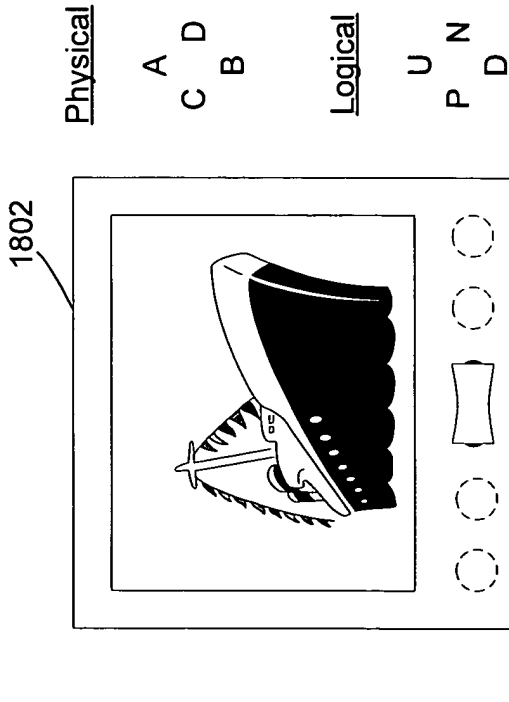
Physical Orientation:	Logical Orientation Based on Rotation			
	Original	90-deg	180-deg	270-deg
A	U	D	D	U
B	D	U	U	D
C	P	P	N	N
D	N	N	P	P



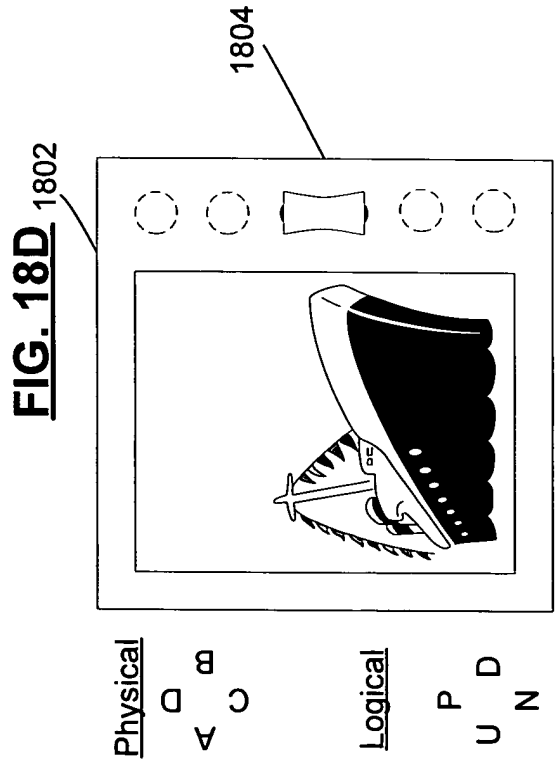
**FIG. 18B**



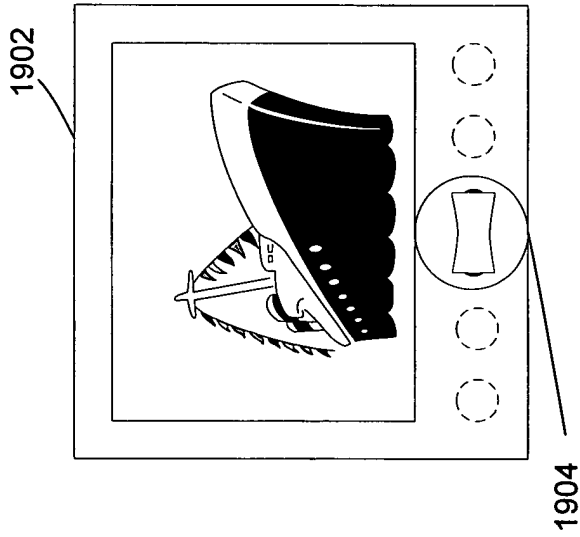
**FIG. 18C**



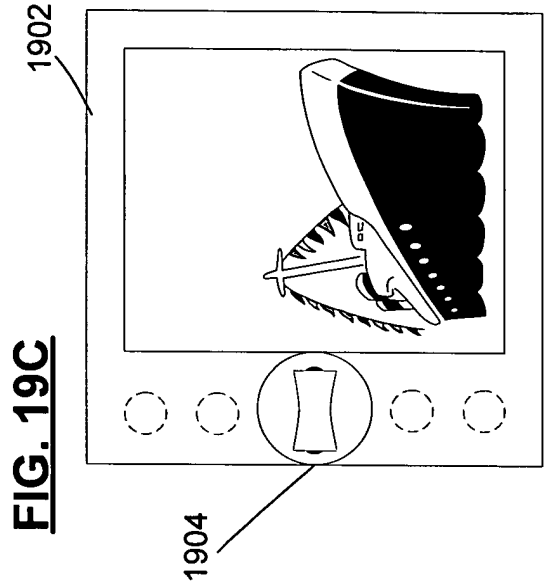
**FIG. 18A**



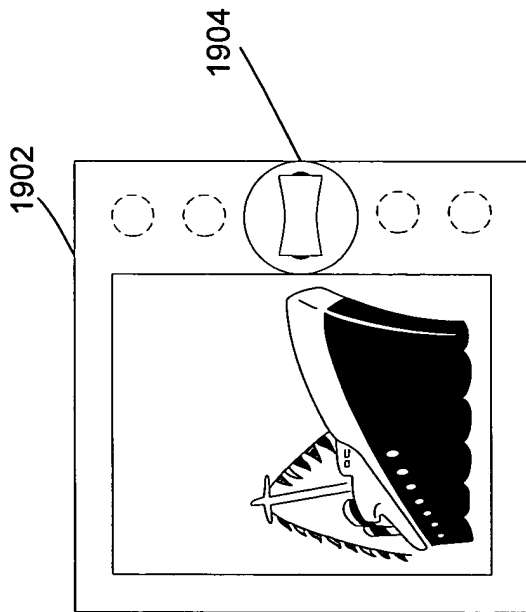
**FIG. 18D**



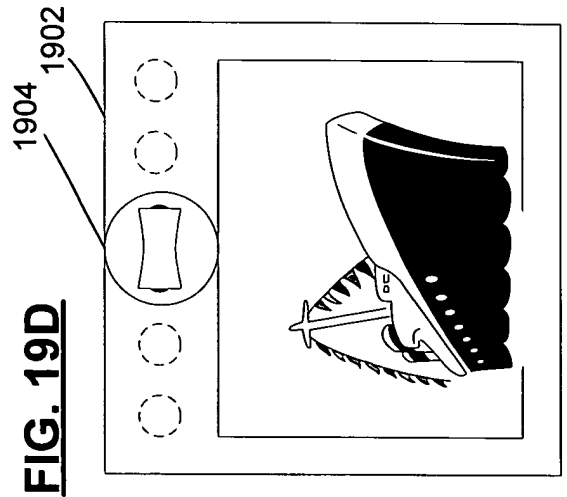
**FIG. 19B**



**FIG. 19C**



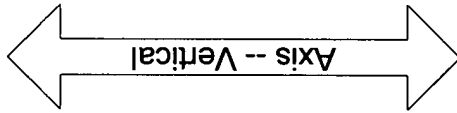
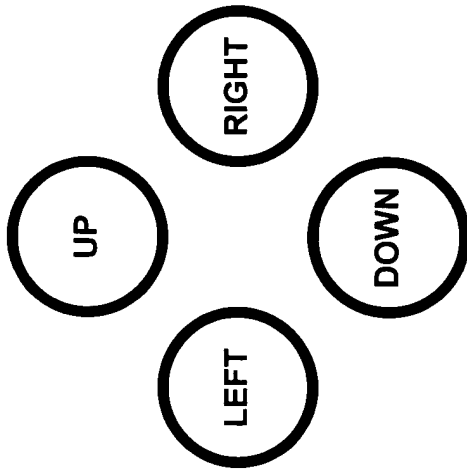
**FIG. 19A**



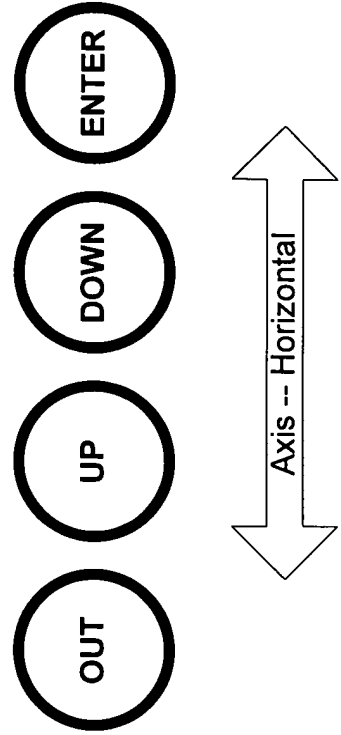
**FIG. 19D**



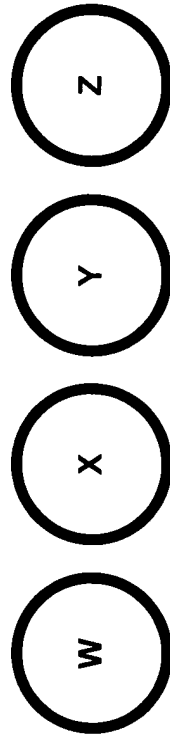
**FIG. 20A**



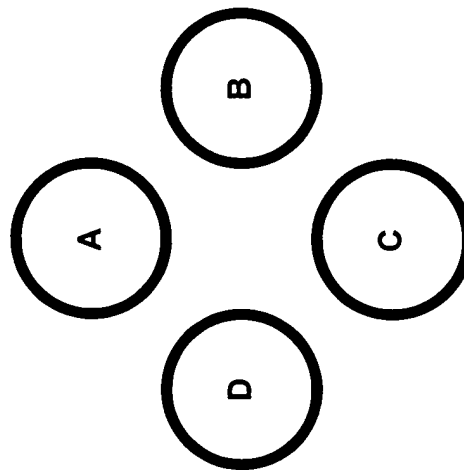
**FIG. 20B**



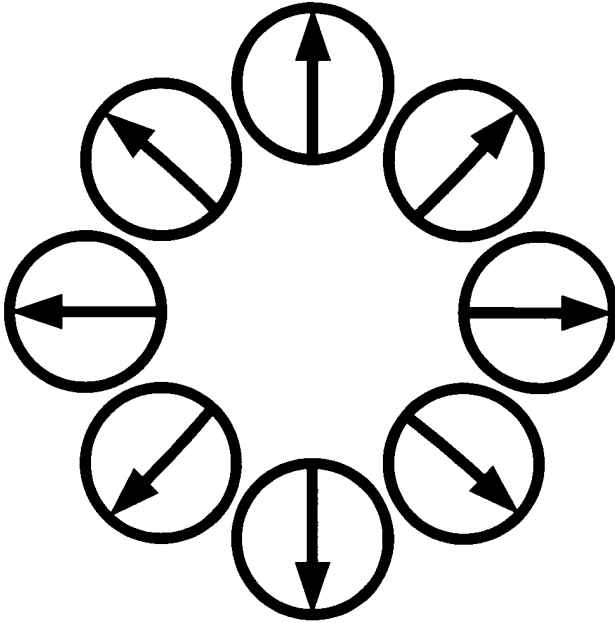
**FIG. 20D**



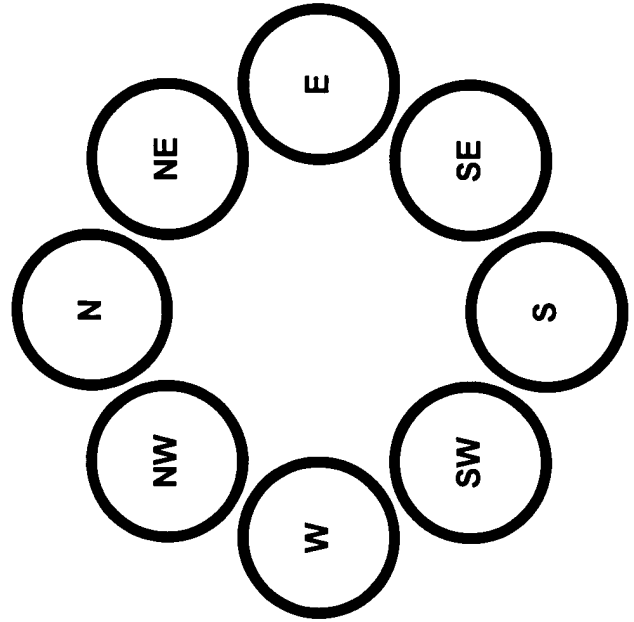
**FIG. 20C**



**FIG. 21B**



**FIG. 21C**



**FIG. 21A**

